

H-SERIES DMR RADIOS

EMPOWERED COMMUNICATIONS



Hytera was a founding member of the DMR Association and was the first company to successfully deploy DMR Tier II and Tier III systems. Since then, Hytera has been a leading provider of DMR radios, and has continuously improved our products based on customer feedback.

The Hytera H-Series of DMR radios and repeater systems is the culmination of this experience and spirit of innovation. The HM782 Mobile Radio is the next-generation in creative style and functionality that elevates the industry standard in professional digital two-way radios.

The HM782 is the new state-of-the-art in mobile radios, providing a more efficient and reliable experience with loud and clear audio, intuitive user interface, and gateway connectivity between radio and data networks.

HM782 Mobile Radio and Compact Gateway

THE NEW STANDARD OF QUALITY AND PERFORMANCE



For In-Vehicle Communications, Desktop Dispatching, and Expanding Coverage Areas with Voice and Data Connectivity

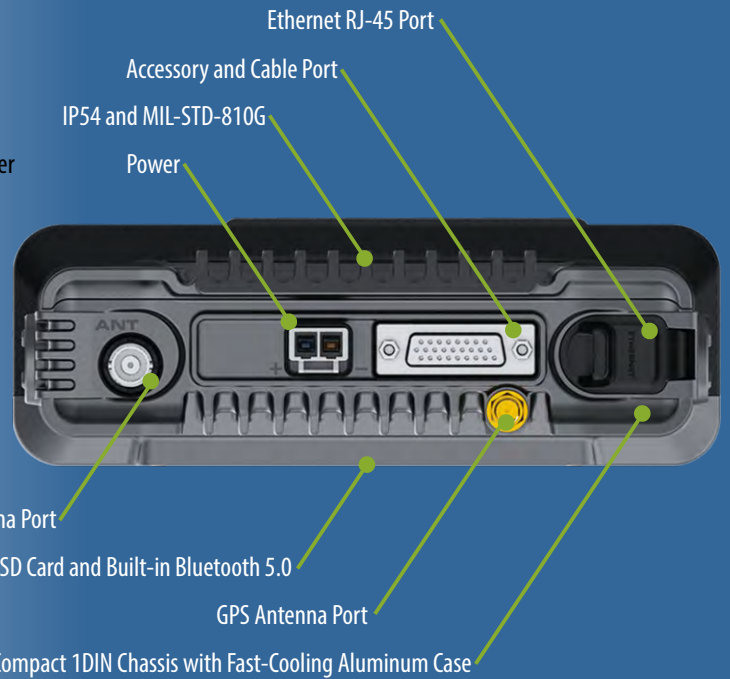

Multi-System Flexibility

The HM782 can be deployed in Analog and Digital Conventional, MPT and XPT Trunking, DMR Tier II and Tier III Trunking, IP Multi-Site Connect, and DMR Simulcast Systems.



Greater Calling Flexibility

The HM782 supports Individual Calls (radio to radio, radio to dispatcher), Group Calls (one radio to many, dispatcher to many), All Call (broadcast call to all radios, transmit only), and Telephone Calls (with connectivity to PSTN, PABX or SIP networks).



Clear and Bright Display

The HM782 features a 2.4-inch, 240x300 HD TFT-LCD display with an intuitive six-grid navigation interface with large type and icons. The display supports 262,000 colors, and is clearly visible in bright sunlight.



Enhanced Worker Safety

The HM782 radios are designed for worker safety with an easy access emergency button, emergency calling, and priority interrupt.

Lone Worker prompts the user to press a key at preset intervals to indicate they are safe.

Large tactile knobs and piano-style buttons provide easy access that keep eyes on the road.



Louder and Clearer Audio

Hytera provides industry-leading audio quality through an optimized forward-facing loudspeaker and AI-based voice enhancement with deep learning ability that can accurately extract voice from noise in real time and decreases unwanted background noises as loud as 30db.



Enhanced GPS Location Tracking

The HM782 reports current location information to other radios, the dispatcher, or third-party applications in real time, enhancing the efficiency of visualized dispatch applications.

GPS data is transmitted during voice calls for immediate location targeting, and GPS data can be compressed to increase channel capacity and reduce hardware cost.



Higher Security

The HM782 supports Digital End-to-End and Over-the-Air Encryption for voice and data. Hardware encryption is implemented through a built-in encryption card. Advanced software encryption uses the ARC4 and AES encryption algorithms.



Durable and Rugged

IP54 compliant for water and dust ingress, and MIL-STD- 810 G for shock and humidity.

THE HM782 IS THE NEW STANDARD OF RADIO NETWORK FLEXIBILITY



APPLICATION EXAMPLES: The HM782 can extend coverage range, connect multiple radio sites, provide wireless data transmission, and support multiple simultaneous mode functions.

Back-To-Back

The HM782 can be deployed Back-to-Back to enable communication between analog and digital radios, or radios with different frequencies. Two HM782 radios can be deployed Back-to-Back, or one radio and a repeater can be used.

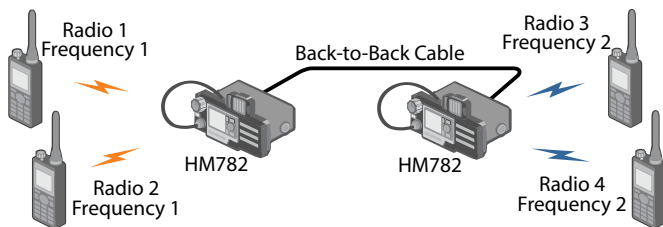

Wireless Link

In situations where a wired IP network is unavailable between two repeaters, two HM782 radios using different frequencies can provide a wireless link between the repeaters.

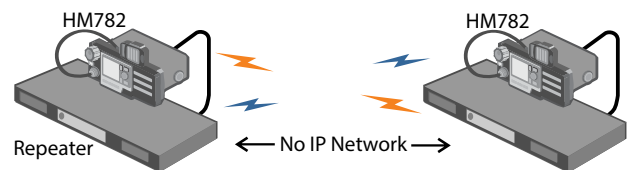

IP Transit

Multiple HM782 mobile radios can be connected to an Ethernet/IP network to provide a reliable and cost-effective method to connect remote radio sites and extend coverage areas. IP Transit can connect radio sites with digital radios using different frequencies.

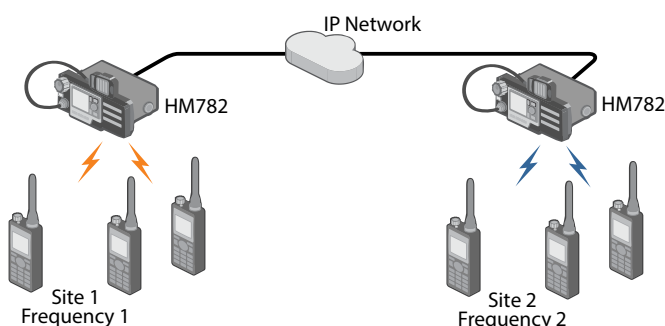

Clarity Transmission

The Clarity Transmission feature provides a wireless data path between remote network devices and a central network management station. HM782 radios function as compact gateway devices and provide wireless channels that transparently transmit data without any modification, and can be deployed in a variety of monitoring and industrial control processes.

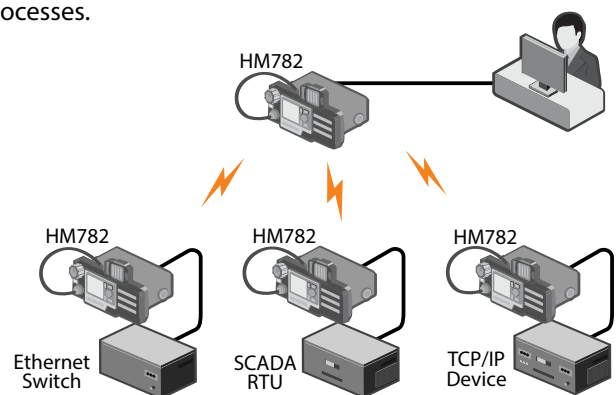

FLEXIBLE CONFIGURATIONS

The HM782 can be deployed in a variety of configurations to meet any mobile radio application.

Standard Conventional Control Head

The HM782 can be installed near the driver as a single unit with the control head and handheld microphone.



Standard
Control Head

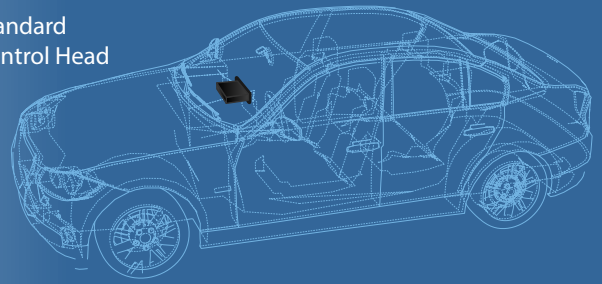

Single or Dual Remote Control Heads

The HM782 can be deployed with a remote control head that is connected via a cable to the radio installed under the seat or the rear of the vehicle compartment. Two remote control heads to be installed in different locations within the vehicle for multiple users or easy access to the radio in large vehicles.



Single Remote
Control Head

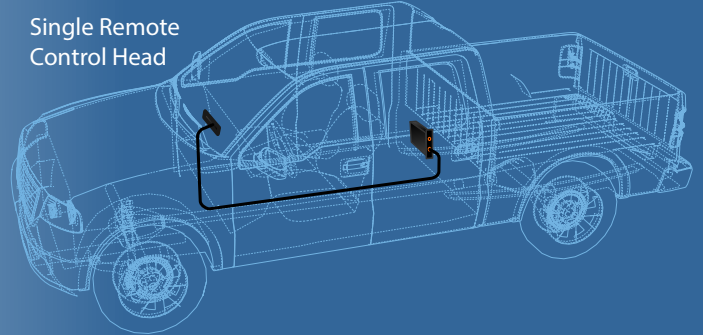

Standalone Desktop

The HM782 can also be deployed in a case with a power supply for desktop dispatching applications, for repeater applications connecting multiple radio sites, or gateway applications to provide wireless data transmission.



Dual Remote
Control Heads

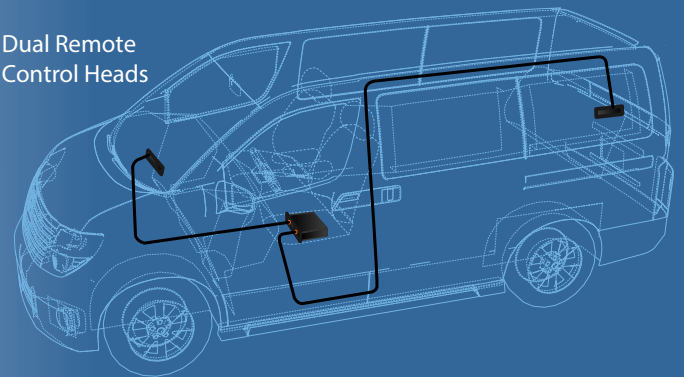

STANDARD ACCESSORIES

- SM16A1 Palm microphone without keypad
- BRK08 Mounting bracket and hardware
- PWC10 Vehicle power cable
- POA33 Fuse
- GPS04 GPS antenna (with GPS models)

OPTIONAL ACCESSORIES



SM09D1
External Speaker



SM10A1
Desktop Microphone



PS22002
External
Power Supply



SM19A1
Palm PTT Microphone with
keypad and emergency button



SM27W2
Bluetooth Remote Speaker Mic
with charging cable



PS16001-H
Base Station Chassis
Power Supply with GPS cable

Contact Hytera or your Local Hytera Dealer for more information on additional HM782 accessories.

SPECIFICATIONS

General	
Frequency Range	UHF 350-470MHz, VHF 136-174MHz
Channel Capacity	1,024 Channels (512 Analog, 512 Digital)
Zone Capacity	64 Zones with 256 Channels per Zone
Channel Spacing	12.5kHz / 20kHz / 25kHz
Operational Voltage	13.6V ±15%
Current Drain	Standby: <0.5A Receive: <2.0A Transmit: 1W <3A, 5W <4A, 25W <8A, 45/50W <12A
Weight	56.1oz (1,520g)
Dimensions (HxWxD)	2 7/16" x 6 31/32" x 7 1/16" (61.5 x 177 x 179mm)
Frequency Stability	± 0.5ppm
Antenna Impedance	50Ω
Display	LCD 2.4", 240x320, 262,000 colors, 10 rows
Bluetooth	BT 5.0 BLE+EDR
Encryption (Optional)	Advanced end-to-end digital (128/266bit) DMRA encryption. Additional license required.
Receiver	
Digital Sensitivity	0.18μV (BERs 5%)
Analog Sensitivity	0.16μV (Typical) (12dB SINAD) 0.18μV (12dB SINAD)
Adjacent Selectivity	TIA-603: 60dB@12.5kHz, 70dB@20/25kHz ETSI: 60dB@12.5kHz, 70dB@20/25kHz
Spurious Response Rejection	TIA-603: 70dB@12.5/20/25kHz ETSI: 70dB@12.5/20/25kHz
Intermodulation	TIA-603: 70dB@12.5/20/25kHz ETSI: 65dB@12.5/20/25kHz
Blocking	TIA-603: 80dB ETSI: 84dB
Hum and Noise	40dB@12.5kHz, 43dB@20kHz, 45dB@25kHz
Rated Audio Power Output	Internal (20 Ohm load) 3W, 8W Max External (8 Ohm load) 8W, 20W Max
Rated Audio Distortion	≤3%
Audio Response	+1 to -3dB
Conducted Spurious Emission	<-57dBm

Transmitter	
RF Power Output	High Power: UHF: 1-45W, VHF: 5-50W
FM Modulation	11K0F3E @ 12.5kHz 14K0F3E @ 20kHz 16K0F3E @ 25kHz
4FSK Digital Modulation	12.5kHz Data Only: 7K60FXD 12.5kHz Data and Voice: 7K60FXW
Conducted/Radiated Emission	-36dBm <1GHz, -30dBm >1GHz
Modulation Limiting	±2.5kHz @ 12.5kHz ±4.0kHz @ 20kHz ±5.0kHz @ 25kHz
FM Hum and Noise	40dB @ 12.5kHz, 43dB @ 20kHz, 45dB @ 20/25kHz
Adjacent Channel Power	60dB @ 12.5kHz, 70dB @ 20/25kHz
Audio Response	+1 to -3dB
Audio Distortion	≤3%
Digital Vocoder Type	AMBE+2™

Environmental	
Operating Temperature	-22°F to +140°F (-30°C to +60°C)
Storage Temperature	-40°F to +185°F (-40°C to +85°C)
ESD	IEC 61000-4-2 (Level 4) ±8kV Contact, ±15kV Air
Dust and Water Ingress	IP54 Standard
Humidity	Per MIL-STD-810 C/D/E/F/G Standard
Shock and Vibration	Per MIL-STD-810 C/D/E/F/G Standard

GPS (5 Satellites visible at nominal 130dBm)	
Time to First Fix Cold Start	<60 Seconds (Typical TTFF)
Time to First Fix Hot Start	<10 Seconds (Typical TTFF)
Horizontal Accuracy	<5 meters

All specifications are subject to change without notice due to continuous development.

Ordering Information	
HM782-Uv	UHF 350-470MHz, 1-45W
HM782-V1	VHF 136-174MHz, 5-50W
HM782-G-BT-Uv	UHF 350-470MHz, 1-45W, with GPS and Bluetooth
HM782-G-BT-V1	VHF 136-174MHz, 5-50W, with GPS and Bluetooth



Hytera US Inc

8 Whatney, Suite 200, Irvine, CA 92618
(954) 846-1011

1363 Shotgun Road, Sunrise, FL 33326
(954) 846-1011

www.hytera.us
info@hytera.us



Hytera is a trademark of Hytera
© 2024 Hytera US Inc. All Rights Reserved.
Hytera retains right to change the product design and specification.
Hytera_HM782_DS-C

KELRAD

Kelrad Authorized Dealer:
Kelrad
Sales . Rentals . Service
4405 International Blvd
NW Suite 118
678-218-9900.
info@kelrad.com